



BETA 3027N 20 Hydraulische werkplaatspers met verschuifbare perscilinder

Certificeringen en normen



ROBUSTNESS

Een dik, precisiegelast frame met een poedercoating geeft de pers langdurige sterkte en duurzaamheid, waardoor een ongeëvenaarde betrouwbaarheid na verloop van tijd wordt gegarandeerd

DUURZAAMHEID

Het onophoudelijke streven naar componenten van hoge kwaliteit draagt bij tot het minimaliseren van slijtage van mechanische onderdelen, wat zorgt voor een uitzonderlijke duurzaamheid

VEELZIJDIGHEID

Deze robuuste en toch compacte persen zijn de perfecte oplossing voor elke gebruiker. Ontworpen met ruimte in gedachten, bieden ze de kracht en betrouwbaarheid die u nodig hebt zonder afbreuk te doen aan uw werkomgeving.

Afmetingen

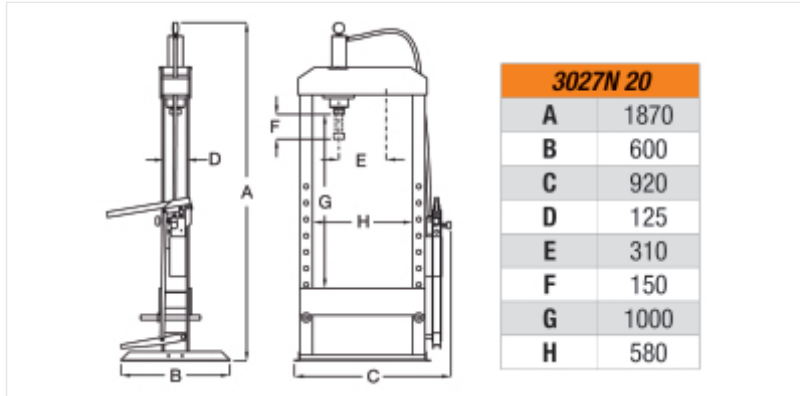

CE

Certificeringen en normen

Referenties

	Art.	H mm	L mm	L1 mm	P mm	
030270102	3027N 20	1870	920	580	600	130

Scan de QR-code om toegang te krijgen tot het
Specificaties, media en documentatie in één klik.

